

## CUBE MX FLOOR TO CHANNEL INSTALLATION INSTRUCTIONS

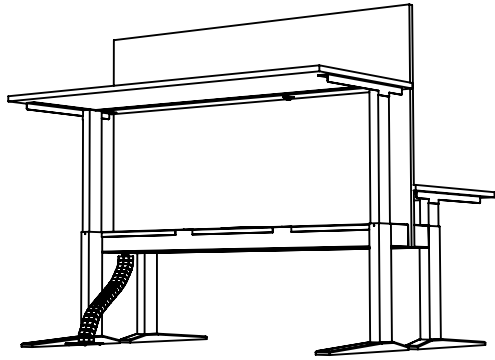

### Cable Snake Kit Contents: FLOOR TO CHANNEL

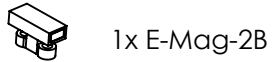

1x E-Mag-2B

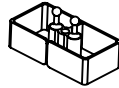

1x 0.5m Cube MX String  
(17x Chain Links)

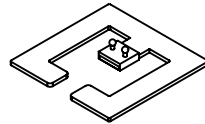

1x Easy-Floor

### Floor to Channel Kit Part Numbers

**BLACK** 147230

**WHITE** 147231

**SILVER** 147232

### Shortening Chain Links

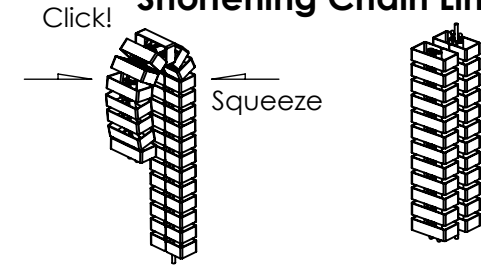

Determine required length. Roll Chain Links over itself and squeeze together. Chain links will separate.

### Floor To Channel Installation

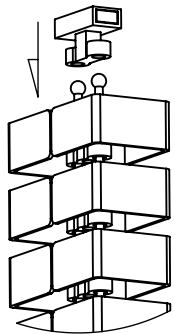

Assemble the E-Mag-2B onto the 2 x Pins of the Cable Snake Chain Link. Click the 2 pins of the Easy-Floor into the opposite (female) end of the Cable Snake Chain Link.

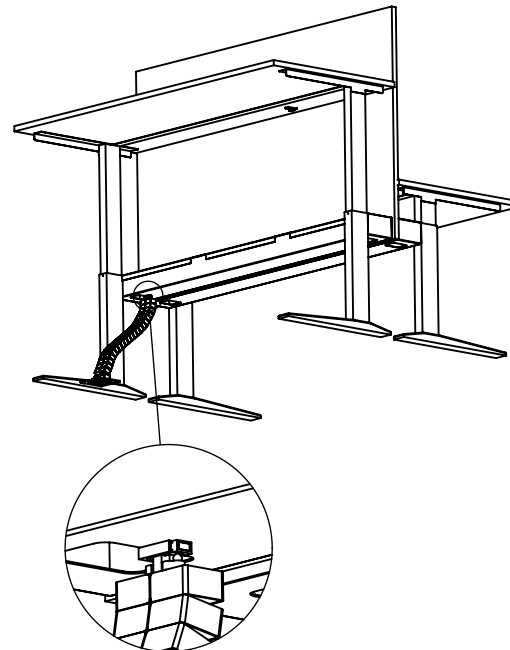

Locate the magnet to the underside of the channel near the opening where the cables enter / exit the channel

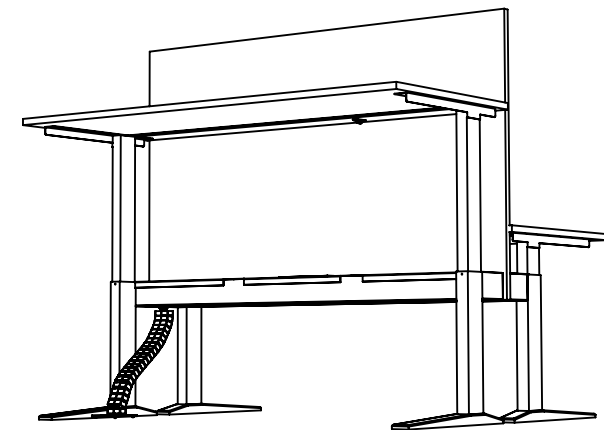

\*Note: Magnets will not stick to aluminium components