



The stylish and simple design of the PHOENIX incorporates the OE Elsafe QIKFIT system, providing a cost effective desk rail to suit most power, USB, data and AV requirements.

The PHOENIX is available in standard lengths which incorporates either two or four socket outlets and comes with a selection of data tiles and blank tiles allowing for on-site configuration to specific requirements.

The elegant design of the PHOENIX compliments any office decor, with the anodised aluminium extrusion rail contrasting perfectly with the moulded plastic components which are available in either black or white.



## Standard unit lengths

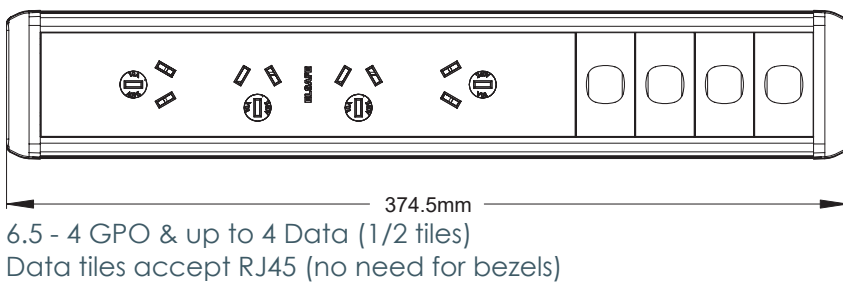
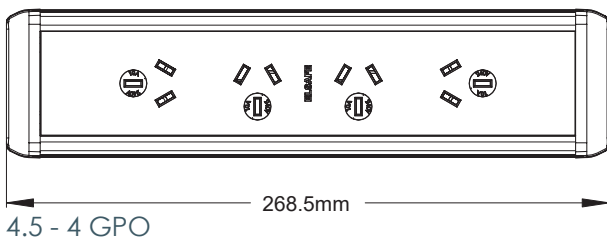
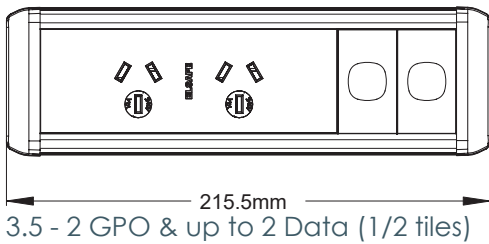
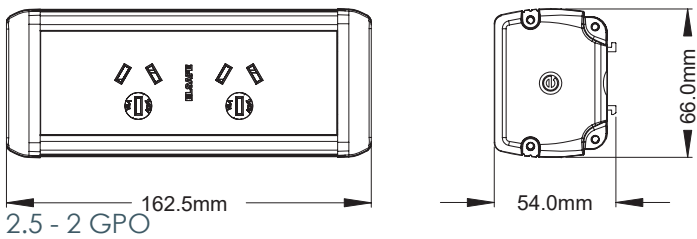

## Fixing methods

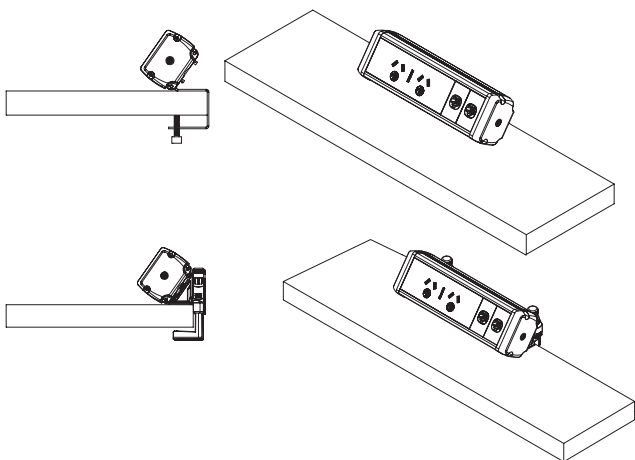

## Features

### Configuration:

Power only / Data only / Combined (Power, USB Charging & Data/AV)

### Insulation:

Reinforced insulation

### Testing:

100% testing - continuity, polarity, insulation & earth

### Rating

PHOENIX with Wieland GST entry are rated to 20Amp

### Soft Wiring (power)

Power wired to Wieland GST connector allows starter cables to be changed to suit requirements, especially useful during moves and changes (CHURN)

### Soft Wiring (data)

As well as soft wired power, PHOENIX can be fitted with soft wired data

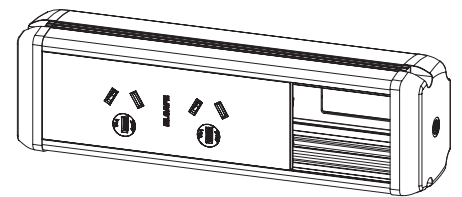

PHOENIX 3.5 COMPRISING OF:  
1 x QF45 4GPO

2 x QF5 BLANK TILES

2 x QF5 AUNZ CUT OUT TILES

OR  
2 x QF5 KEYSTONE TILES  
(ONLY SUPPLIED ON REQUEST)

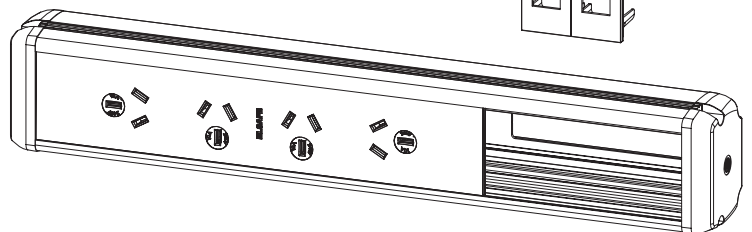

PHOENIX 6.5 COMPRISING OF:  
1 x QF45 4GPO

4 x QF5 BLANK TILES

4 x QF5 AUNZ CUT OUT TILES

OR  
4 x QF5 KEYSTONE TILES  
(ONLY SUPPLIED ON REQUEST)