

polar beacon



Taking up less than 80mm of desk space the OE Elsafe PolarBEACON can be mounted either directly on the surface or through a standard 80mm grommet hole.

Super cool in white, PolarBEACON allows the user easy access to power, USB fast charging and data in a unique vertical module, maximising services while using the minimum of space.

Used in conjunction with under-desk cable management PolarBEACON offers a complete workstation solution.

Polar Beacon can be configured with Australian or international power sockets.

Polar Beacon is NOT retractable.



polar beacon TECHNICAL

Common Modular Components*

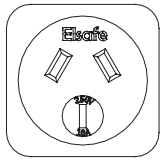

Australian/New Zealand

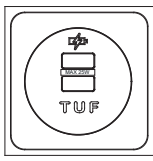

TUF-PD 25W USB-fast Charger

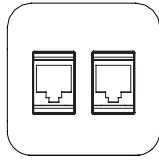

Twin Data

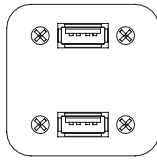

Twin USB Data Transfer

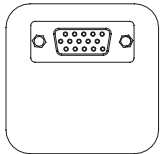

VGA

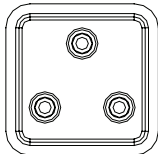

RCA

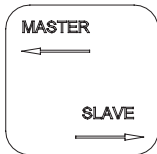

Master/Slave

*see website for more

Typical dimensions

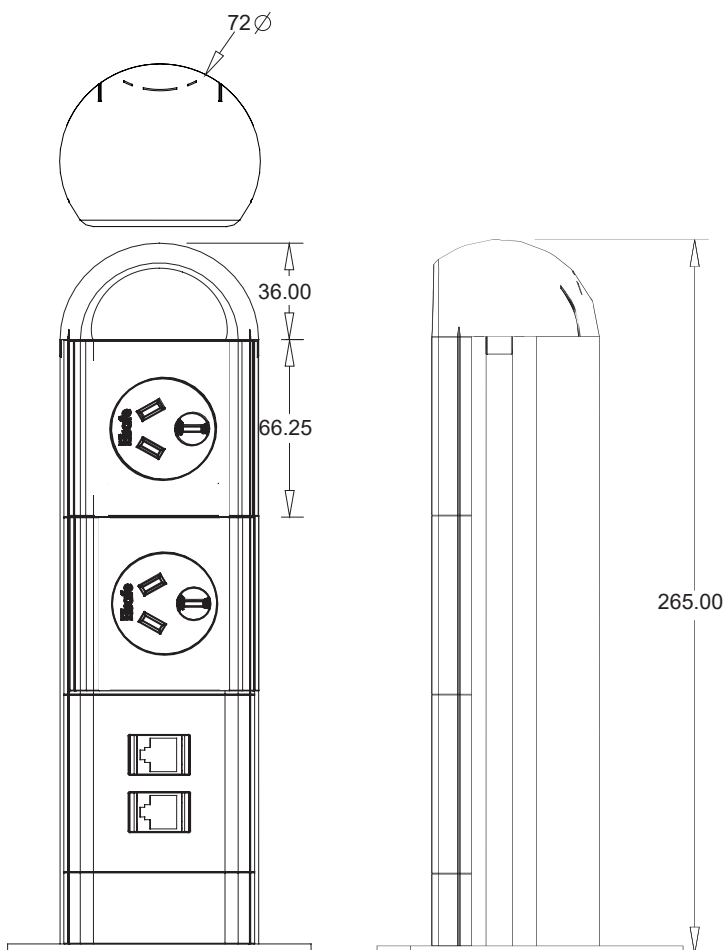

other configurations available, please call sales

Features

Configuration:

Power only / Data only / Combined (Power & Data/ AV)

There is internal segregation between Power and Data/AV in the combination PolarBEACON.

Insulation:

Earthed aluminium casing with fire retardant ABS fascias.

Increased flexibility:

PolarBEACON can be fitted to either the desktop via an 80mm access hole or directly to the surface. PolarBEACON can also be fitted to the underside of the desk, leaving the desk surface completely clear.

Testing:

100% testing - continuity, polarity, insulation & earth

Soft Wiring (power)

Power hard-wired to Wieland GST connector allows starter cables to be changed to suit requirements, especially useful during moves and changes (CHURN)

Soft Wired Data

As well as soft-wired power, PolarBEACON can accommodate soft wired data. Using our in-line couplers, data cables can be changed "on-site" to accommodate changes in length often associated with churn.